

speCtra®



Spectra® Synergy Gold

Dual Powered Electric Breast Pump

Instructions for Use

Spectra Synergy Gold Breast Pump Instructions for Use

CONTENTS

1. Important Safeguards	3-4
2. Important Symbols	4-6
3. Indications for Use	6
4. Components and Assembly	6-8
5. Display	9
6. Button Control	9
7. Pumping Guide	10
8. Getting Started	11-12
9. How to Single/Dual Pump	13
10. Finding your Flange size	13
11. Sanitizing and Cleaning	14-15
12. Breast Milk Storage and Thawing	16
13. Thawing and Using Stored Breast Milk	17
14. Night Light	17
15. Troubleshooting	18
16. Use and Storage Environment	19
17. Technical Specifications	19
18. Warranty	20
19. Electromagnetic Compatibility (EMC)	21-24

These symbols identify all instructions that are important to the safety of the user. Failure to observe these instructions can lead to personal injury or damage to the breast pump.



WARNING can lead to serious injury or death.



NOTE can lead to minor injury.



NOTE can lead to material damage.



TIP useful or important information that is not related to safety.

Spectra Synergy Gold Breast Pump Instructions for Use

These instructions apply to the Spectra Synergy Gold Breast Pump, model MM011400.

1. IMPORTANT SAFEGUARDS

① If you are a mother who is infected with Human Immunodeficiency Virus (HIV), pumping breast milk will not reduce or remove the risk of transmitting the virus to your baby through your breast milk.

② Before each use, visually inspect each individual component for damage, including cracks, chips, tears, discoloration, or deterioration. If damage to the individual components is observed, please discontinue use until the parts have been replaced.



READ THIS ENTIRE MANUAL BEFORE USE PUMP AND KEEP IT FOR FUTURE REFERENCE.

When using electrical products, basic safety precautions should always be followed.



TO REDUCE THE RISK OF SHOCK OR ELECTROCUTION:

1. Do not use while bathing.
2. Do not place or store product where it can fall or be pulled onto the ground or into water or other liquids.
3. Do not place in or drop into water or other liquids.
4. Do not reach for a product that has fallen into water or other liquids; unplug the product immediately if this occurs.
5. Do not sanitize the kit in microwave oven.
6. Never immerse pump unit in water.
7. Always unplug electrical devices immediately after using.



TO REDUCE THE RISK OF BURNS, ELECTROCUTION, FIRE, OR INJURY TO PERSONS.

1. This product should never be left unattended when plugged into an electrical outlet.
2. Do not leave this product unattended around infants or children. Close supervision is necessary when this product is used near infants or children.
3. Use this product only for its intended use as described in this manual. Do not use any attachments or accessories not recommended by the Uzinmedicare co./Spectra Baby USA.
4. Never operate this product if it has a damaged cord or plug.
5. Do not use the product if it is not working properly, if it has been dropped or damaged, dropped into water, or if any parts are broken or missing.
6. Keep the cord away from heated surfaces
7. Never use while driving, sleeping or if drowsy.
8. Do not use outdoors or operate where aerosol spray products are being used or where oxygen is being administered.
9. Do not disassemble or modify the product.
10. Do not place small parts in mouth. Do not inhale or swallow small parts.
11. Allergic reactions may occur. Immediately discontinue use of the product if allergic reactions occur.
12. The product must be stored properly, away from excessive lint, dust, light (including sunlight), etc. which can adversely affect safety and essential performance of this product.
13. AC/DC adaptor must be in a position that is easy to unplug from power outlet.

Spectra Synergy Gold Breast Pump Instructions for Use





14. Use only the power cord that comes with the Spectra Synergy Gold breast pump and, make sure the voltage of the power cord is compatible with the power source.
15. If the power adapter outer casings become loose or are separating, stop using the product and contact Spectra Baby USA immediately -*separation of the casing can result in electric shock.*
16. This breast pump should not be operated while traveling on an airplane.
17. Plug the power cord into the breast pump first and then into the wall outlet.
18. Dry all parts thoroughly after cleaning. Do not store wet or damp part(s) as they may develop mold.
19. When cleaning the pump unit, unplug it before you start.
20. Pumping can induce labor; do not use while pregnant.















NOTE: If you feel pain in your breast or nipple, please try one of the following options:

1. Lower your pump suction (vacuum suction setting) to a more comfortable level.
2. Turn the pump off, pull the adapter plug out of wall outlet, and break the suction before you remove the breast shield from your breast, by inserting a finger between your breast and the flange.
3. Make sure you are using the correct flange size.
<https://www.spectrababyusa.com/guide/>
4. If the issue persists, contact a healthcare/lactation professional. You can make an appointment with one of our lactation consultants for an online consult at www.spectrababyusa.com/lactationservices

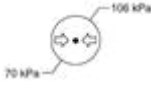

2. IMPORTANT SYMBOLS

Graphic of the Symbol	Standard from which the symbol was referenced	Reference/Registration Number	Symbol Title	Symbol Description
	IEC 60601-1	Table D2-9	General Action sign	General mandatory action sign
	IEC 60601-1	Table D1-20	Type BF	Type BF Applied Part
	IEC 60417	5009	Power On / Off	To identify the switch or switch position by means of which part of the equipment is switched on in order to bring it into the stand-by condition.
	ISO 15223-1:2016	5.3.8	Transport/Storage/Operation Humidity	Indicates the range of humidity to which the medical device can be safely exposed
	ISO 15223-1:2016	5.3.1	Fragile	Indicates a medical device that can be broken or damaged if not handled carefully

Spectra Synergy Gold Breast Pump Instructions for Use

Graphic of the Symbol	Standard from which the symbol was referenced	Reference/Registration Number	Symbol Title	Symbol Description
	ISO 15223-1:2016	5.1.3	Date of Manufacture	Indicates the date when the medical device was manufactured
	ISO 7000	0623	This Way Up	To indicate correct upright position of the transport package
	IEC 60601-1	Table D2-2	Danger, Warning	Can lead to serious injury or death
	IEC 60417	5031	DC	Direct current
	ISO 15223-1:2016	5.3.7	Operation Temperature	Indicates the temperature limits to which the medical device can be safely exposed
	ISO 15223-1:2016	5.3.4	Keep Dry	Indicates a medical device that needs to be protected from moisture
	EN 50419:2006	—	This product should not be mixed with other commercial wastes for disposal.	WEEE—Subject to waste electrical and electronic equipment regulations, i.e. not for general waste
	ISO logo	—	Quality System	These trademarks for the ISO logo
	ISO 7010	P001	General Prohibition Sign	General prohibition sign and template for constructing a prohibition sign
	IEC 60417	5172	Class II	CLASS II equipment
	ISO 15223-1:2016	5.1.1	Manufacturer	Indicates the medical device manufacturer
	ISO 15223-1:2016	5.3.9	Operation Atmospheric Pressure	Indicates the range of atmospheric pressure to which the medical device can be safely exposed
	ISO 15223-1:2016	5.1.7	Serial Number	Indicates the manufacturer's serial number so that a specific medical device can be identified

Spectra Synergy Gold Breast Pump Instructions for Use

Graphic of the Symbol	Standard from which the symbol was referenced	Reference/Registration Number	Symbol Title	Symbol Description
	ISO 7000	2403	Stacking Limit by Number	To indicate that the items shall not be vertically stacked beyond the specified number, either because of the nature of the transport packaging or because of the nature of the items themselves
	IEC 60601-1	Table D.2-10	Refer to IFU	Refer to Instructions for use that should be followed

3. INDICATIONS FOR USE

The Spectra Synergy Gold breast pump is a powered breast pump to be used by lactating women to express and collect milk from their breast.

The Spectra Synergy Gold breast pump is intended for single users in a hospital setting. It is also intended for home use by a single user.

4. COMPONENTS AND ASSEMBLY



Prior to using the breast pump for the first time, sanitize the flanges, backflow protectors, silicone valves, bottles, bottle covers, and mounting rings in boiling water for 5 minutes. See Section 11 for instructions.

The kits are designed for individual use. Never share the kits.



NOTE: To prevent distortion or damage, do not boil for more than 5 minutes during sanitization process, as parts may become distorted.

Spectra Synergy Gold Breast Pump Instructions for Use

How to assemble Backflow Protector

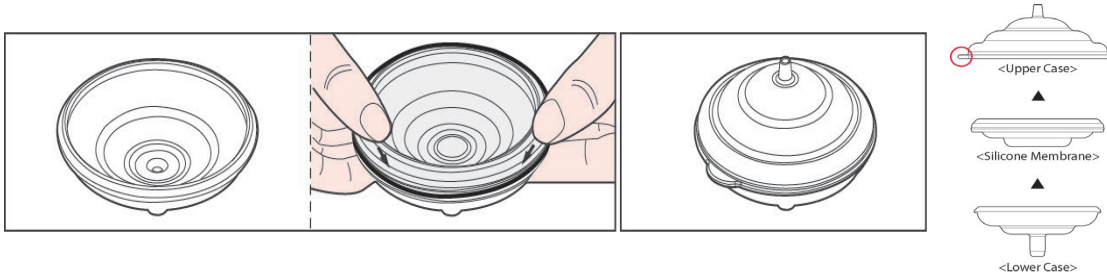

1. Insert the white silicone membrane into the lower case. The lower case has a larger port than the upper the upper case.
2. The lip on the silicone membrane lip must be firmly seated over the rim of the lower case to ensure proper suction.
3. Place upper case over assembled lower case, making sure all 3 pieces fit securely to form a perfect seal.

How to assemble the Power Cord

Your power cord has 2 components. You need to assemble them prior to use. See directions below:

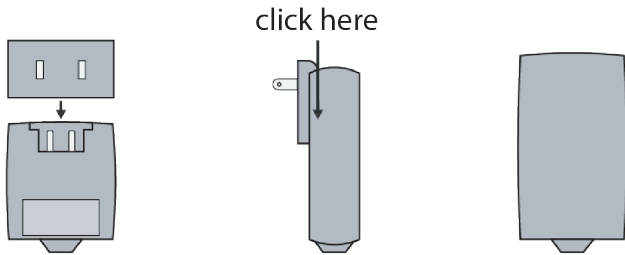

1. Hold power cord base and slide the adapter on the 2 flat prongs.
2. You should hear a loud click once the 2 parts are well-connected.
3. When assembled correctly, the 2 parts cannot be easily separated, and the assembly looks like a one-piece power cord.

Spectra Synergy Gold Breast Pump Instructions for Use

How to assemble Pump Kit

Always wash hands with soap and water and make sure your pump accessories are clean and dry before you assemble and use your pump kit. The part numbers in the drawings below refer to Table 1, Components and Assemblies.

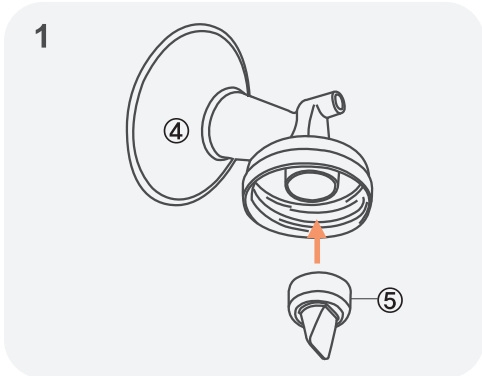

Press and twist ⑤ silicone valve into ④ flange to attach

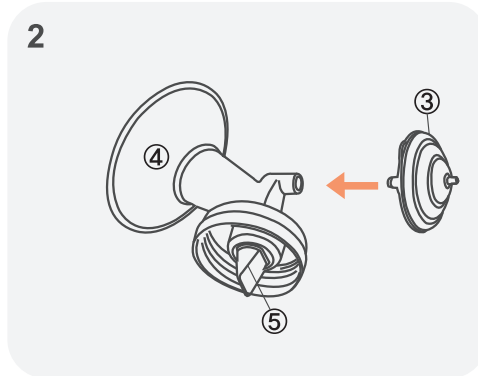

Gently press and twist ③ backflow protector assembly into ④ flange



Screw ⑥ bottle onto ④ assembled flange

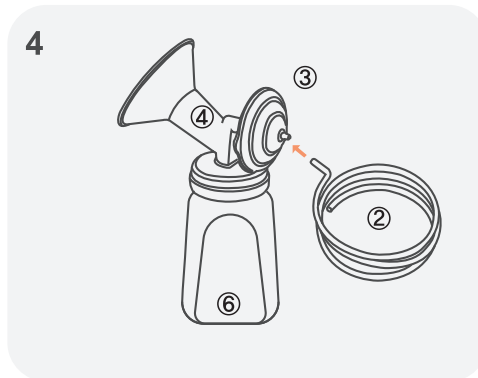

Twist ② tubing into ③ backflow protector assembly



NOTE: There are two ports on the backflow protector assembly. The larger port goes into the flange, the smaller connects to the tubing.

Spectra Synergy Gold Breast Pump Instructions for Use

5. DISPLAY

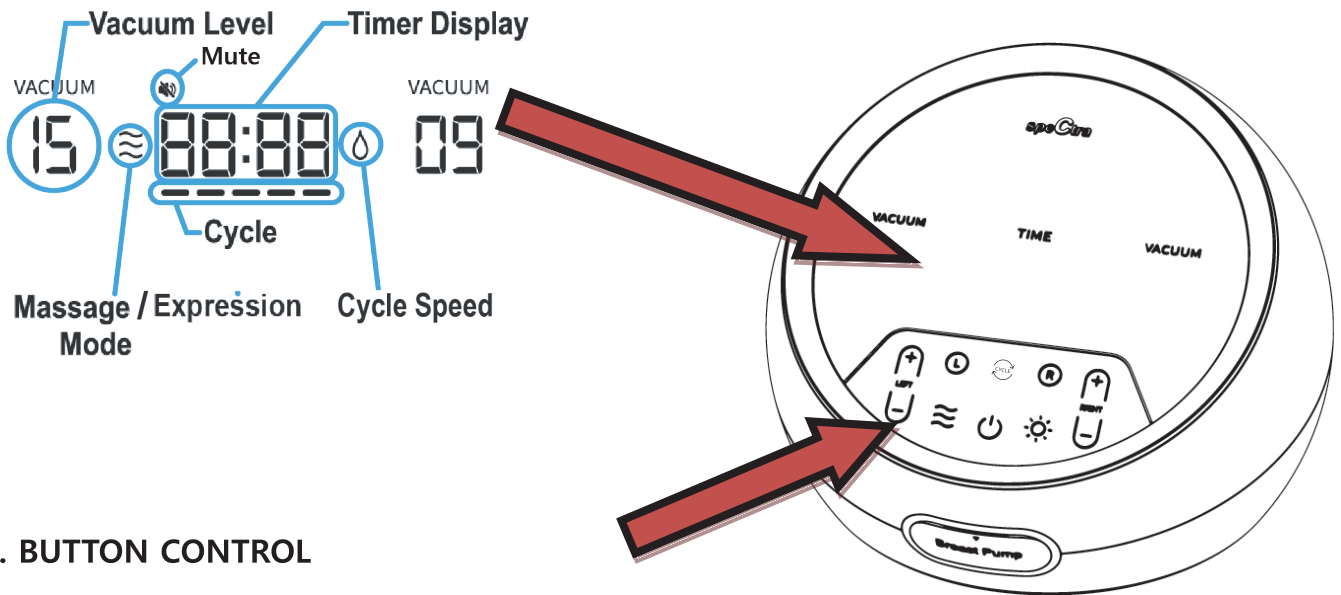

6. BUTTON CONTROL

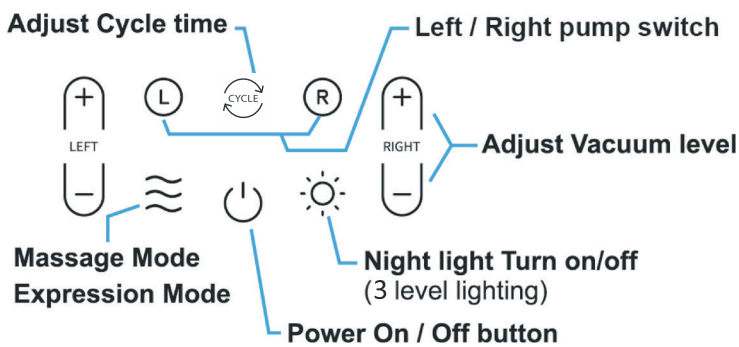

Time: 00.00 The Timer Display always starts at 00.00 when you turn on the pump.

Sound: Press and hold the Message/Expression button for 3 seconds to mute or unmute the beep sound that occurs when any touch button is pressed. When this symbol is displayed on the left of the Timer Display the sound has been muted.

2-Phase Mode: Message Mode - Expression Mode - Each symbol appears, on the right or left of the Timer Display, depending on the mode that is being used.

Cycle Speed: This symbol appears below Timer Display. There are five (5) cycle speed levels in both expression and message mode.

L or R: Located on the right and left side of the vacuum strength adjustment button, they let you select the flange/breast side (Left or Right) you are adjusting the vacuum strength of during your pumping session.

Your pump's vacuum strength level varies from L01-L15 in expression mode and L01-L05 in message mode and is independently adjustable on each side. To adjust the vacuum level, press the +/- buttons. These +/- button symbols appears on both sides of the control panel since you can increase your vacuum on each flange side (Left and/or Right) independently during pumping sessions.

Your pump has 10-cycle levels in expression mode and 5-levels in message mode. To adjust the cycle speed, press the drop symbol any time after you turn on the pump. Your cycle is the same on both sides (Left and Right) during pumping sessions— **and cannot be set independently.**

Spectra Synergy Gold Breast Pump Instructions for Use

7. PUMPING GUIDE

1. Relax, clear your mind, listen to soothing music. If your baby is not present, look at pictures or videos of your baby.
2. Sit in a comfortable chair and if needed to support lower back, use a pillow.
3. Stimulate your letdown reflex before pumping. Some women have found that gently massaging their breasts with circular motion from the wall of their chest toward the nipple or applying a warm compress on their breasts prior to pumping helps trigger their letdown reflex.
4. Make certain that your flange is the appropriate size for your nipple.
5. Always wash hands well with soap and water before pumping.
6. Clean and disinfect the pump (see Section 11) and clean countertop with disinfectant wipes prior to each use.

We encourage you to breastfeed your baby whenever you can even when using the breast pump.

Spectra Synergy Gold Breast Pump Instructions for Use

8. GETTING STARTED



NOTE: Your Spectra Synergy Gold breast pump has two separate setting options for either the left and right breasts allowing each side to be adjusted individually.

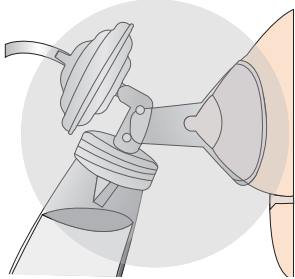

Center the breast shield on your nipple so that the nipple is positioned in center of the tunnel opening without rubbing or pressing into the sides of the funnel.

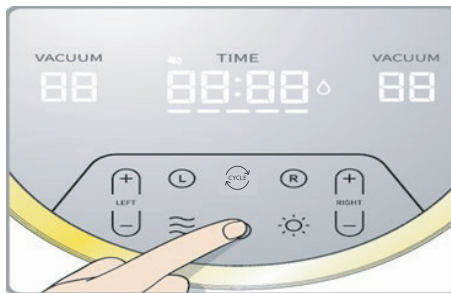

Press the power button. Your pump is on; the timer displays 88:88. Also displayed is the setting you used during your last pumping session: sound mode, phase mode—massage or expression, and cycle speed.



When your pump is on prior to starting to pump, your control panel will display the settings of your last pumping session. You can change the settings before you start your new session: Press the  3-wave button once to switch from massage mode to expression mode (vice versa). Hold it for 3 seconds to mute or unmute the beep sound that occurs when the touch button is pressed.



If you are single pumping, select which breast by pressing the L or R button. You need to select both L and R to double pump. Adjust the vacuum strength to a comfortable level by using the “+” or “-” symbol. You can also adjust cycle speed using the  symbol.



To stop double pumping, press the power button then remove milk collection kit from your breast(s). To stop pumping on one side, press L or R to select the side you want to turn off.

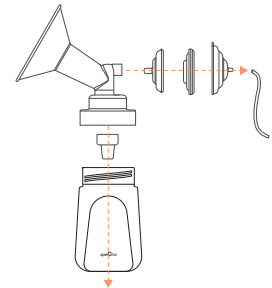

Once you stop pumping, twist to detach the backflow protector from the flange. Remove the flange from the milk collection bottle and close the bottle tightly with the bottle lid and store safely.



NOTE: The Spectra Synergy Gold pumps are designed to turn off automatically after 30 minutes.

Spectra Synergy Gold Breast Pump Instructions for Use

- **Vacuum Suction Setting** - Adjust the vacuum level by pressing the  buttons.

The vacuum suction level refers to how strongly the pump will 'suckle' – a higher number is higher vacuum. Please be careful when setting the vacuum level on the Spectra Synergy Gold. Some women find that milk expression is faster on higher vacuum levels. However, it is important to not set vacuum level so high that it makes you uncomfortable, as the resulting pain can impact your milk flow.

Therefore, we suggest that you start off with the vacuum level on low and then gradually increase the vacuum suction to a comfortable level. You may find that level of vacuum that you are comfortable with varies significantly, from day to day, during the day, and even during the same expression session.

Remember: Your vacuum strength level can be set independently on the left and right side during your pumping session

- **Cycle Speed Setting** – Adjust the cycle speed by pressing the  button.

The cycle speed is measured in CPM (cycles per minute) on your breast pump and refers to how many times the pump 'suckles' and releases per minute. Your Spectra Synergy Gold has been designed with variable cycle settings so that you can find the setting that suits your body best.

Changing the cycle speed can make a dramatic difference to successful expressing for some women. Every woman is different, so experiment to find what speed works best for you.

- **Message and Expression Modes.** 

Message Mode: In this mode, you have 5-cycle speeds—64, 67, 70, 73, and 76 and 5 vacuum strength levels—L01-L05. The 3-wave symbol is displayed on the left side of the timer in message mode.

Use message mode at the start of your pumping session or anytime you need to generate a let-down during your pumping session.

Expression Mode: This mode has 5-cycle speeds--38, 42, 46, 50, and 54 and 15 vacuum strength levels—L01-L15. In expression mode, a drop is displayed on the right side of the Timer Display. To adjust the cycle speed, press the drop symbol any time after you turn on the pump. Your cycle is the same on both sides (Left and Right) during pumping sessions—**it cannot be set independently.**

After letdown begins, once the milk is flowing, you should switch to expression mode, to start slower and deeper suckles, to draw down the milk. This mode has a slower cycle speed and higher vacuum suction level.

Please adjust the cycle speed and vacuum strength in expression mode and message mode to find the combination setting that works best for you.

TIP: The Spectra Synergy Gold remembers your settings automatically for your next session. If you want to start pumping on different settings than those used during your previous session, adjust the settings once you turn on your pump before you start pumping. Remember you will need to adjust the vacuum on each side, left and right, separately.



Spectra Synergy Gold Breast Pump Instructions for Use

9. HOW TO SINGLE/DUAL PUMP

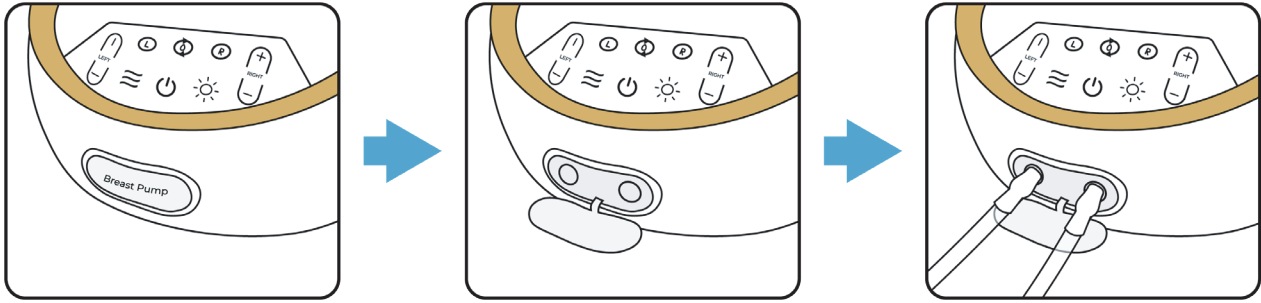

1) Remove the air cap

2) Connect tubing from each milk collection kit to an air nozzle.

10. FINDING YOUR FLANGE SIZE

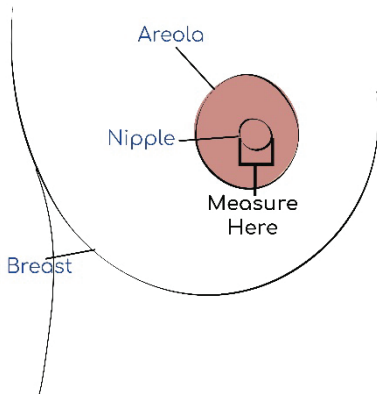

Use a ruler, a measuring tape, or a flange measurement guide.

Measurement must be in millimeters (mm)/1cm = 10mm

A guide is available on spectrababyusa.com.

Measure the diameter of your nipple at base, do not include areola (see picture above.) If the diameter of your nipple is:

Up to 16mm use 20mm flange

Up to 20mm use 24mm flange

Up to 24mm use 28mm flange

Up to 28mm use 32mm flange

The 24mm and 28mm flange sizes are included with your pump. Contact Spectra Baby USA for the other sizes mentioned above.

Spectra Synergy Gold Breast Pump Instructions for Use

11. SANITIZING AND CLEANING -

Sanitizing regularly before then after use and at least once a day, is especially important if your baby is less than 3 months old, was born prematurely, or has a weakened immune system due to illness or medical treatment.

Sanitize Accessories Prior To First Use:



CAUTION: Do not wash/sanitize the tubing. It should never come into contact with breast milk since the Spectra Synergy Gold pumps are closed-system pumps.



NOTE: Use a designated basin to clean your pump parts; do not wash them in the sink.

First, wash all parts in warm soapy water and rinse well. Next, sanitize as detailed below. **To avoid tearing or damaging the seals, never insert anything into the duckbill valves when cleaning them.**

Accessories (clear/yellow): breast shield/flange, upper and lowercase of backflow protector, bottle, nipple mounting ring, bottle cover and airtight cap:

- Use a pot large enough to fit all your parts—if the pot is too small, parts discoloration and/or distortion may occur, damaging your parts.
- Fill with water so that when your parts are added the water is at least 4" above the parts.
- Remove parts from pot, place lid on the top of the pot, and bring to boil.
- Once the water reaches boiling point, turn off the heat and then submerge accessories in boiling water—the water should continue to boil.
- Remove accessories after 3-5 minutes.

Silicone accessories (white): duckbill valves, backflow protector membranes, and bottle nipples:

- Soak them in boiling water for no more than 2 minutes.



TIP: Do not expose silicone accessories to high heat to prevent melting, warping, or damaging them.

Place all cleaned and sanitized parts to dry on a clean paper towel to drain. Once the parts are dry, assemble the pump before you store or use it.



WARNING: Do not boil for more than 5 minutes during sanitization process, as parts may become distorted.

AFTER EACH USE:

- Disassemble all parts that come into contact with the breast and breast milk - flanges, valves (duckbill or valve with membrane, bottles, airtight cap and backflow protectors).
- Wash each piece in warm soapy water and rinse with hot water.
- Place parts to air dry on a clean paper towel.
- Once the parts are dry, assemble the pump before you store it or use it.

Using non-antibacterial soap is recommended to ensure that you are not leaving a film on your flanges that can impede the natural secretions from your mammary glands

Spectra Synergy Gold Breast Pump Instructions for Use

CAUTION: NEVER wash or sanitize your tubing as it will never come into contact with your breast milk.



To avoid damaging the breast pump, DO NOT use it with wet tubing. If tubing becomes moldy, discontinue using and replace immediately.

- Parts can be cleaned in a dishwasher. If using a dishwasher, place items on wash cycle on the top rack using a closed top basket or a mesh bag, and air dry. Do not use heat dry.
- Microwave bags can be used if the proper amount of water is added. Follow the instructions of the bag manufacturer.

In the dishwasher

- **Note: Cleaning the airtight cap in warm soapy water is recommended.**
- Rinse bottle parts and any other feeding items by holding them under running water. The water can be warm or cold.
- Place parts in the top rack of the dishwasher. (Be sure to place small items inside a closed-top basket or mesh laundry bag so they don't end up in the dishwasher filter.) If possible, run the dishwasher using hot water and a heated drying cycle (or sanitizing setting); this can help kill more germs.
- Wash your hands with soap and water before removing and storing cleaned items.
- Remove parts from dishwasher - If items are not completely dry, place them on a clean, unused dish towel or paper towel to air dry thoroughly before storing in an area free of dust or dirt. Do not use a dish towel to rub or pat items dry because doing so may transfer germs to the items.



WARNING:

- Microwaving your parts can result in distortion and/or discoloration of the parts. Care must be used.
- Discoloration may occur over time, this is cosmetic and does not affect the chemical composition of the parts.



NOTE: The above guidelines are for healthy, full-term babies. If your baby was born prematurely, has a weakened immune system due to illness, has other health challenges, or is hospitalized, consult your hospital and your child's health care provider for cleaning requirements.

Spectra Synergy Gold Breast Pump Instructions for Use

12. BREAST MILK STORAGE AND THAWING

It is important that you store your expressed breast milk properly to help it stay fresh and maintain its anti-bacterial properties as well as its nutritional and immunological qualities.

STORAGE RECOMMENDATION OF FRESHLY EXPRESSED BREAST MILK

Guidelines for Healthy, Full-Term Babies

LOCATION	TEMPERATURE	STORAGE TIME
Countertop	77°F/25°C or colder (room temperature)	Up to 4 hrs.
Refrigerator	40°F/4°C	Up to 4 days
Freezer	0°F /-18°C or colder	Up to 6 months recommended (12 months is acceptable)
Insulated Cooler Bag	59°F/15°C	24 hrs. (refrigerate or freeze after 24 hrs.)

Source: CDC - Human Milk Storage Guidelines

https://www.cdc.gov/breastfeeding/recommendations/handling_breastmilk.htm

- Storage times may vary for premature or sick babies. Please contact your health care provider for instructions.
- When storing breastmilk, use breastmilk storage bags, which are made for freezing human milk. You can also use clean glass or hard BPA-free plastic bottles with tight-fitting lids. Do not use containers with the recycle number 7, which may contain BPA. Do not use disposable bottle liners or other plastic bags to store breastmilk.
- Write the date on the storage container. Include your child’s name if you are giving the milk to a childcare provider.
- Refrigerate or chill milk right after it is pumped, if possible. You can put it in the refrigerator, place it in a cooler or insulated cooler pack, or freeze it in small (2 to 4-ounce) batches for later feedings. If you’re not going to use refrigerated breastmilk within 4 days of pumping, freeze it right after pumping. Freeze in small amounts (2 to 4 ounces, or ¼ to ½ cups) for later feedings. Leave about an inch at the top of the container, to allow for expansion. Loosely tighten the cap on the bottles, then fully tighten bottle caps or lids after the milk is completely frozen. Store milk in the back of the freezer, not on the shelf of the freezer door, so that it doesn't start to thaw out. Milk stored at 0°F or colder is safe for longer durations, but the quality of the milk might not be as high.

Type	Storage Time
Freezer -18°C (0°F) or colder temperature	Within 6 months is best. Up to 12 months is acceptable.

Source: Office of Women’s Health (OWH) Milk Storage Recommendations
<https://www.womenshealth.gov/breastfeeding/pumping-and-storing-breastmilk>

Spectra Synergy Gold Breast Pump Instructions for Use

13. THAWING AND USING STORED BREAST MILK

- Always make sure to check the date on the milk's container before using. Do not use undated milk, or milk that has been stored too long.
- Thaw the oldest breastmilk first. Thaw frozen milk in the refrigerator or under cool, running water.
- Breastmilk does not need to be warmed. Some moms prefer to serve it at room temperature. Some moms serve it cold.
- If you decide to warm the breastmilk:
 - Keep the container sealed while warming.
 - Hold it under warm, not hot, running water, or set it in a container of water that is warm, not hot.
 - If warm water is not available, heat a pan of water on the stove. Once the water is warm, not boiling, remove the pan from the stove and place the milk container in the pan. It may take approximately 20 minutes to bring cold milk to room temperature. Never warm the milk container directly on the stove!
 - Never put a bottle or bag of breastmilk in the microwave. Microwaving creates hot spots that could burn your baby and damage the milk.
 - Test the temperature before feeding it to your baby by dropping some on your wrist. The milk should feel warm, not hot.
- Once thawed, gently swirl the container to mix the cream part of the breastmilk that may rise to the top back into the rest of the milk. Do not shake the milk. This can make some of the milk's valuable parts break down.
- After thawing, milk should be stored in the refrigerator for no more than 24 hours.
- Never refreeze thawed milk. Throw away previously frozen milk that is not used within 24 hours.
- If you are combining expressed breast milk with cold breast milk, make sure all the milk is at the same temperature.

Feeding Breast Milk

It is recommended that you establish and maintain your milk supply prior to introducing the bottle to your baby (approximately 6 weeks.)

- Inspect bottle, nipple, and other feeding tools before and after each use. Stop using and replace damaged, cracked and/or torn nipples immediately.
- Do not attempt to enlarge the nipple hole.
- Do not bottle feed an infant without adult supervision.
- Do not use your bottle nipple as a pacifier.

14. NIGHT LIGHT

The innovative built-in LED light allows you to select one of two lighting levels, so you always have a light source available that won't disturb your baby when expressing milk.

Spectra Synergy Gold Breast Pump Instructions for Use

15. TROUBLESHOOTING

Condition	Possible Causes	Checks	Solutions
No Power	Power cord/AC Adapter	Check if the power cord is not connected or it is damaged.	Make sure power cord is attached to pump unit. Plug into the outlet. If it is damaged, replace it.
No Suction	Air tube	Check the tubing is connected to the pump unit. Check if air tube is not damaged.	Connect the air tube to the pump unit. If air tube is damaged, replace it.
	Valve	Check if the valves are connected to breast shield properly.	Attach valve to flange—Twist valve into flange. Replace the valve if it is torn or damaged.
Low Suction	Vacuum Level	Check vacuum level.	Increase vacuum level.
	Defective assembly kit	Check the kit assembly.	Disassemble and reassemble accessory kit.
	Breast shield*	Check if there is a problem with the breast shield—is it the right size; is it damaged?	Confirm your flange size using the flange measurement guide on spectrababyusa.com ; If breast shield is damaged, replace it.
	Valve	Check if there is damage in duckbill valve head—tear or other damage or if clear valve membrane is damaged.	Replace the valve.
	Vacuum Level	Too high suction	Set to a lower suction level.
Pain	Breast shield	Check if there is a problem with the breast shield—is it the right size?	Confirm your flange size using the flange measurement guide on www.spectrababyusa.com .
	Cycle Speed	Check cycle speed.	Change cycle speed to comfortable level.

If suggested solution does not resolve the issue, turn off pump, stop pumping, and break suction to remove flange if necessary. If your pump is malfunctioning, contact the warranty team at warranty@spectrababyusa.com. If you have questions on how to properly use your pump or on lactation issues, consult a lactation or health professional. You can make an appointment with one of our lactation consultants for an online consult at www.spectrababyusa.com/lactationservices.

Spectra Synergy Gold Breast Pump Instructions for Use

16. USE AND STORAGE ENVIRONMENT

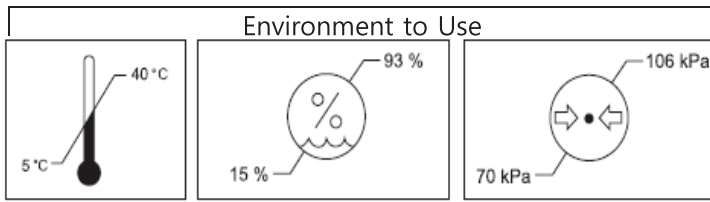

Temperature

Humidity

Pressure

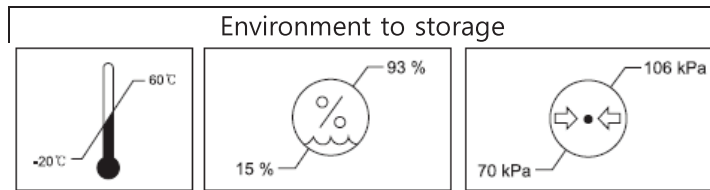

Temperature

Humidity

Pressure

17. TECHNICAL SPECIFICATIONS

Protection Type: Class II

Weight: 1.8kg, Power consumption: 60VA

Expected Spectra Synergy Gold Service Life is 3 years

The following adapter must be used.

Manufacturer: Dongguan Shilong Fuhua Electronic Co., Ltd.

Model: UES24LCP-120200SPA

Input: 100-240 V a.c., 50/60 Hz, 500 mA

Output: 12 V d.c., 2 A

1. Type of protection against electric shock: Class II equipment
2. Degree of protection against electric shock: Type BF applied parts
3. Classification according to the degree of protection against ingress of water: IP22
4. This equipment is not suitable for use in the presence of flammable anesthetics or oxygen
5. Mode of operation: continuous operation

VACUUM SUCTION PRESSURE (millimeters of mercury - mmHg)			CYCLE SPEED (Cycle/Min. - CPM)		
Expression Mode		Message Mode	Expression Mode		Message Mode
Level 1: 0 - 50	Level 6: 0 - 160	Level 11: 0 - 230	Level 1: 0 - 50	Level 1: 38	Level 1: 64
Level 2: 0 - 80	Level 7: 0 - 180	Level 12: 0 - 240	Level 2: 0 - 90	Level 2: 42	Level 2: 67
Level 3: 0 - 100	Level 8: 0 - 200	Level 13: 0 - 250	Level 3: 0 - 130	Level 3: 46	Level 3: 70
Level 4: 0 - 120	Level 9: 0 - 210	Level 14: 0 - 260	Level 4: 0 - 160	Level 4: 50	Level 4: 73
Level 5: 0 - 140	Level 10: 0 - 140	Level 15: 0 - 270	Level 5: 0 - 200	Level 5: 54	Level 5: 76

Traveling Outside of the U.S.A

The Spectra Synergy Gold is compatible with multiple voltages. It can be used just about anywhere in the world. The pump adjusts itself to whatever voltage it receives. The only issue is whether the power cord/AC adapter that comes with your pump can physically interface with the socket/wall outlet in the country where you are going. To resolve this issue, you need an international/universal power adapter that can be used in the country where you will be—you don't need a voltage converter. Spectra Synergy Gold uses a two-pronged power cord and does not require a grounded outlet.

For information about traveling with your breast pump and expressed breast milk, visit www.tsa.gov

Spectra Synergy Gold Breast Pump Instructions for Use

18. WARRANTY

This product is warranted by SPECTRA BABY USA, to the purchaser to be free from defects in material and workmanship for a maximum period of two (2) years from the date of purchase. In the event of a defect or failure to conform to this warranty, SPECTRA BABY USA will, at SPECTRA BABY USA's option, replace this product without charge for such replacement or parts at the SPECTRA BABY USA office listed below. The purchaser shall bear all responsibility and expense for returning this product, including risk of loss prior to receipt by SPECTRA BABY USA, as well as shipping, packing and insurance costs.

ANY AND ALL IMPLIED WARRANTIES ARE LIMITED TO THE DURATION OF TWO (2) YEARS FROM THE DATE OF PURCHASE. SOME STATES DO NOT ALLOW LIMITATIONS ON HOW LONG AN IMPLIED WARRANTY LASTS, SO THE ABOVE LIMITATIONS MAY NOT APPLY TO YOU.

THE LIABILITY OF SPECTRA BABY USA, FOR BREACH OF ANY WRITTEN OR IMPLIED WARRANTY IS LIMITED TO THE REPLACEMENT OF THIS PRODUCT. SPECTRA BABY USA WILL HAVE NO LIABILITY UNDER ANY CIRCUMSTANCES FOR ANY INCIDENTAL OR CONSEQUENTIAL DAMAGES. SOME STATES DO NOT ALLOW THE EXCLUSION OR LIMITATION OF INCIDENTAL OR CONSEQUENTIAL DAMAGES, SO THE ABOVE LIMITATIONS MAY NOT APPLY TO YOU.

THIS WARRANTY GIVES YOU SPECIFIC LEGAL RIGHTS. YOU MAY ALSO HAVE OTHER RIGHTS WHICH VARY FROM STATE TO STATE.

SPECTRA BABY USA will have no obligation under this warranty to replace this product and/or its components due to any malfunction or damage caused by accident or arising from misuse, abuse, improper maintenance, unauthorized modification, or connection to an improper power supply. Without limiting the generality of the foregoing, bending or dropping of this product or its components and visible cracking of the equipment housing will be presumed to be defects resulting from misuse or abuse. Accessories that are not expressly manufactured by SPECTRA BABY USA and intended for use with the Spectra Synergy Gold breast pump will immediately void this warranty. A charge will be made for replacement of damaged parts.

If you wish to make a claim under this warranty, please contact the warranty team at warranty@spectrababyusa.com for instructions. You will be required to provide a proof of purchase or receipt.

Spectra Synergy Gold Breast Pump Instructions for Use

19. ELECTROMAGNETIC COMPATIBILITY (EMC)

This equipment needs to be installed and put into service in accordance with the information provided in the user manual [IEC/EN 60601-1-11:2010 Clause 12.3a].

Wireless communications equipment such as wireless home network devices, mobile phones, cordless telephones and their base stations, walkie-talkies can affect this equipment and should be kept at least 1.0 m away from the equipment. [IEC/EN 60601-1-11:2010 Clause 12.3b]

This equipment has been tested and found to comply with the limits for medical devices in IEC 60601-1-2:2014. These limits are designed to provide reasonable protection against harmful interference in a typical medical installation. This equipment generates, uses, and can radiate radio frequency energy and if not installed and used in accordance with the instructions, may cause harmful interference to other devices in the vicinity. However, there is no guarantee that interference will not occur in a particular installation. If this equipment does cause harmful interference to other devices, which can be determined by turning the equipment off and on, the user is encouraged to try to correct the interference by one or more of the following measures.

- Reorient or relocate the receiving device.
- Increase the separation between the equipment.
- Connect the equipment into an outlet on a circuit different from that to which the other device(s) are connected. Consult the manufacturer or field service technician for help.

Essential Performance:

Vacuum level setting: Expected value \pm 50mmHg (Max. 270mmHg)

Cycle setting: Expected value \pm 20%

Backflow protection: Backflow mechanism works at all stages of the pumping session whether the milk collection container is full or not.

It has been tested for immunity to electromagnetic disturbances and passed testing based on certain criteria, such as component failures, changes in programmable parameters or operating mode, cessation or interruption of any intended operation or initiation of any unintended operation.

TABLE 1: Electromagnetic Emissions (IEC 60601-1-2:2014)

This equipment is intended for use in the electromagnetic environment specified below. It is the responsibility of the user of the Spectra Synergy Gold breast pump to ensure that it is used in such an environment.

Spectra Synergy Gold Breast Pump Instructions for Use

Emission test	Compliance	Electromagnetic environment - Guidance
RF Emissions CISPR 11	Group 1	This equipment uses RF energy only for internal function. Its RF emissions thus are very low and are not likely to cause interference with nearby electronic equipment.
RF Emissions CISPR 11	Group B	This equipment is suitable for use in all establishments, including domestic establishments and those directly connected to public low-voltage power supply networks that supply buildings used for domestic purposes.
RF Emissions CISPR 11	Group A	
RF Emissions CISPR 11	Complies	



WARNING: Use of this equipment adjacent to or stacked with other equipment should be avoided because it could result in improper operation. If such use is necessary, this equipment and the other equipment should be observed to verify that they are operating normally.

Spectra Synergy Gold Breast Pump Instructions for Use

TABLE 2: Electromagnetic Immunity (IEC 60601-1-2:2014)

This equipment is intended for use in the electromagnetic environment specified below. It is the responsibility of the user of the Spectra Synergy Gold breast pump to ensure that it is used in such an environment.

Immunity test	IEC 60601 test level	Compliance level	Electromagnetic environment - Guidance
Electrostatic discharge IEC 61000-4-2	± 6 kV contact ± 8 kV air	± 6 kV contact ± 8 kV air	Floors should be wood, concrete or ceramic tile. If floors are covered with synthetic material, the relative humidity should be at least 30%.
Electric fast transient / burst IEC 61000-4-4	± 2 kV for power supply lines ± 1 kV for input / output lines	± 2 kV for power supply lines ± 1 kV for input / output lines	Mains power quality should be typical of a commercial or hospital environment.
Surge IEC 61000-4-5	± 1 kV line(s) to line(s) ± 2 kV line(s) to earth	± 1 kV line(s) to line(s) ± 2 kV line(s) to earth	Mains power quality should be typical of a commercial or hospital environment.
Power frequency and magnetic field IEC 61000-4-8	3 A/m at 50 and 60 Hz	3 A/m at 50 and 60 Hz	Power frequency magnetic fields should be at levels characteristic of a typical location in a typical commercial or hospital environment.
Voltage dips and interruptions IEC 61000-4-11	<5% UT (>95% dip in UT) for 0.5 cycle 40% UT (60% dip in UT) for 5 cycle 70% UT (30% dip in UT) for 25 cycle <5% UT (>95% dip in UT) for 5 secs UT = the a.c. mains voltage before application for the test level.	<5% UT (>95% dip in UT) for 0.5 cycle 40% UT (60% dip in UT) for 5 cycle 70% UT (30% dip in UT) for 25 cycle <5% UT (>95% dip in UT) for 5 secs UT = the a.c. mains voltage before application for the test level.	Mains power quality should be typical of a commercial or hospital environment. During a power outage, the equipment should be powered from a battery or other constant, appropriate power supply.
Conducted RF IEC 61000-4-6	3 Vrms 150 kHz - 80 MHz	3 Vrms 150 kHz - 80 MHz	Portable and mobile RF communications equipment should be used no closer to the Spectra Synergy Gold (including cables) than the recommended separation distance (d), based on the following equations : $d = 1.2\sqrt{P}$ for 150 kHz - 80 MHz $d = 1.2\sqrt{P}$ for 80 MHz - 800 MHz $d = 2.3\sqrt{P}$ for 800 MHz - 2.5 GHz
Radiated RF IEC 61000-4-3	3 V/m 80 MHz - 2500 MHz	3 V/m 80 MHz - 2500 MHz	
			<p>P is the maximum output power rating of the transmitter in watts. d is the recommended separation distance in meters. Field strength from fixed RF transmitters, as determined by an electromagnetic site survey, should be less than the compliance level in each frequency range. Interference may occur in the vicinity of equipment marked with the following symbol.</p> 

a. Field strength from fixed transmitters, such as base stations for radio (cellular/cordless) telephones and land mobile radios, amateur radio, AM and FM radio broadcast and TV broadcast cannot be predicted accurately. If you wish to use the equipment in the vicinity of fixed RF transmitters and you are uncertain about the electromagnetic environment, please consider obtaining an electromagnetic site survey.

Spectra Synergy Gold Breast Pump Instructions for Use

If the measured field strength in the location where the equipment is being used exceeds the applicable RF compliance level above, it is the user’s responsibility to verify that the equipment is operating normally. If abnormal performance is observed, additional measures, such as re-orienting or relocating the equipment, may be necessary.

b. Over the frequency range 150 kHz to 80 MHz, field strengths should be less than 3 V/m.

Table 3: Recommended Separation Distances (IEC 60601-1-2:2014)

This equipment is intended for use in an electromagnetic environment in which radiated RF disturbances are controlled.

Observing the recommended separation distances between this equipment and other portable and mobile RF communications equipment (transmitters) can reduce the likelihood of electromagnetic interference.

Rate Maximum output power of transmitter	Separation distance according to frequency of transmitter [m]		
	150kHz to 80MHz $d=[3.5/\sqrt{P}]$	80MHz to 800MHz $d=[3.5/\sqrt{E1}]$	80MHz to 2.7GHz $d=[7/\sqrt{E1}]$
0.01	0.12	0.04	0.07
0.1	0.37	0.11	0.22
1	1.17	0.35	0.70
10	3.69	1.11	2.21
100	11.67	3.50	7.00

For transmitters rated at a maximum output power not listed above, the recommended separation distance (d) in meters (m) can be estimated using the equation applicable to the frequency of the transmitter, where P is the maximum output power rating of the transmitter in watts (W) according to the transmitter manufacturer.



NOTE 1: AT 80 MHz and 800 MHz, the separation distance for the higher frequency range applies.

NOTE 2: These guidelines may not apply in all situations.

Electromagnetic propagation is affected by absorption and reflection from structures, objects, and people.

 UZINMEDICARE Co.,Ltd
 54, 56, Dongtansandan 5-gil, Hwaseong-si,
 Gyeonggi-do, 18487, Republic Of Korea
 Telephone : +82 31 375 1076
<http://spectrababy.co.kr>